

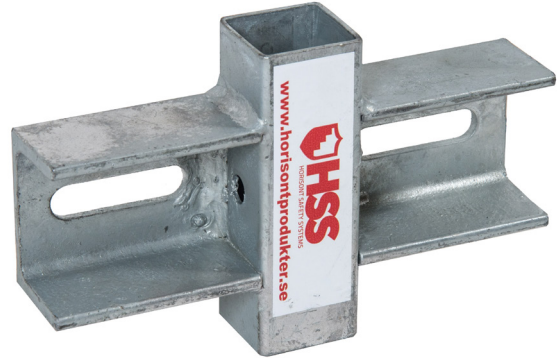



Art. Nr: **HP10488**



 Bultas på befintliga balkongräckesinfästningar. förgjutna på balkonger. t.e.x. "C-Bygel".

 Använd M12 eller M10 med brickor (standard i våra c-byglar = M10).

 Max c-c = 2.4m

 Kompatibel med både våra runda stolpar och virkesstolpe.

 EN13374 A.

 Varmgalvaniserad.

 Vikt: 1,1kg

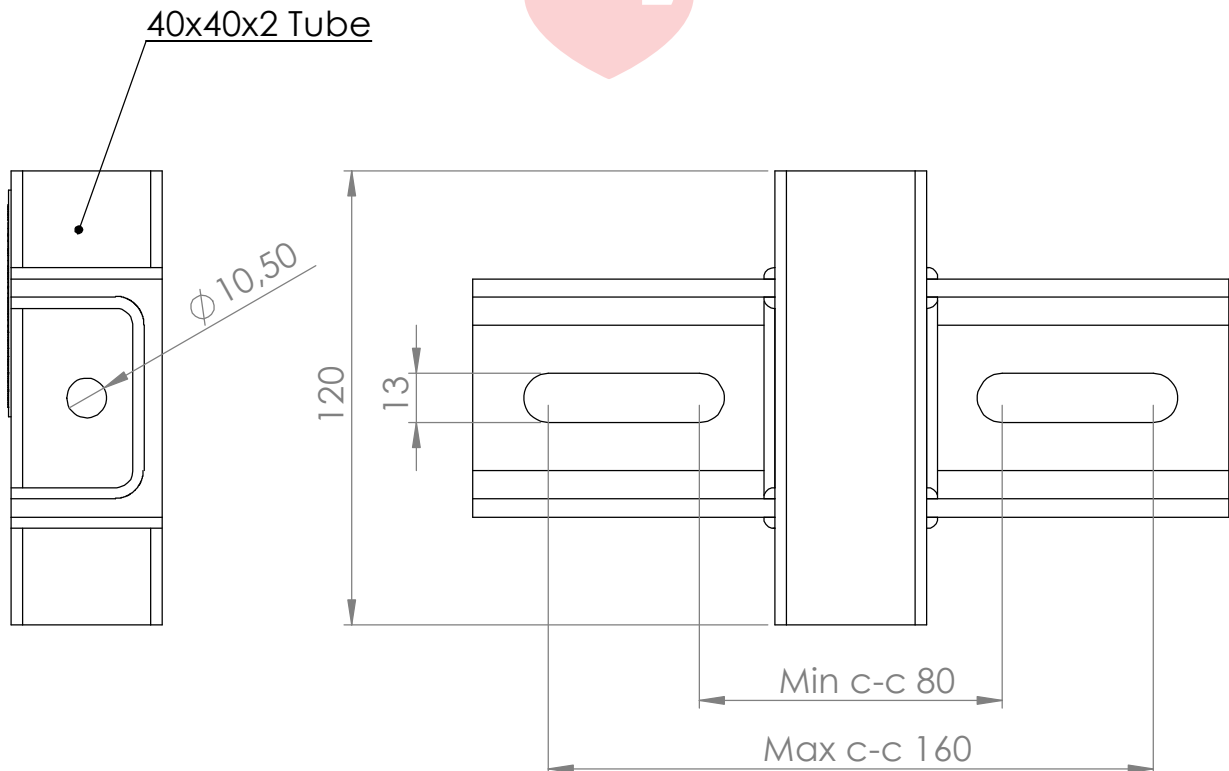

Levereras fördelaktigt i stålkista för fästen HP30557 (500st per korg).